



乐清市裕林电子有限公司

Yueqing Yulin Electronic Co., Ltd

Address: 721 huancheng east road tantou liushi yueqing wenzhou Tel: 0577-27878383

website: www.pilotlamp.cn

fax: 0577-27878383-8027

SPECIFICATION FOR APPROVAL

规格说明书

CUSTOMER'S CODE

本厂代码: FL-PZ-W2016-1-5

DESCRIPTION

品名: 金属信号灯metal signal light

SPECIFICATION

规格: 12mm

DATE

编制日期: 2016-01-06

PART NO.

本厂型号: FL1M-12SJ-1

REFERENCE No.

档案编号: FL-PZ-W2016-1-5-047

| Approved By Customer 编制 | Qualified By 审核 | Form Designer 批准 |
|----------------------------|--------------------|---------------------|
| | | |

FILN 飞林



乐清市裕林电子有限公司
Yueqing Yulin Electronic Co., Ltd

Address: 721 huancheng east road tantou liushi yueqing wenzhou Tel: 0577-27878383

website: www.pilotlamp.cn

fax: 0577-27878383-8027

1. Picture 图片:



3. 图纸 drawing

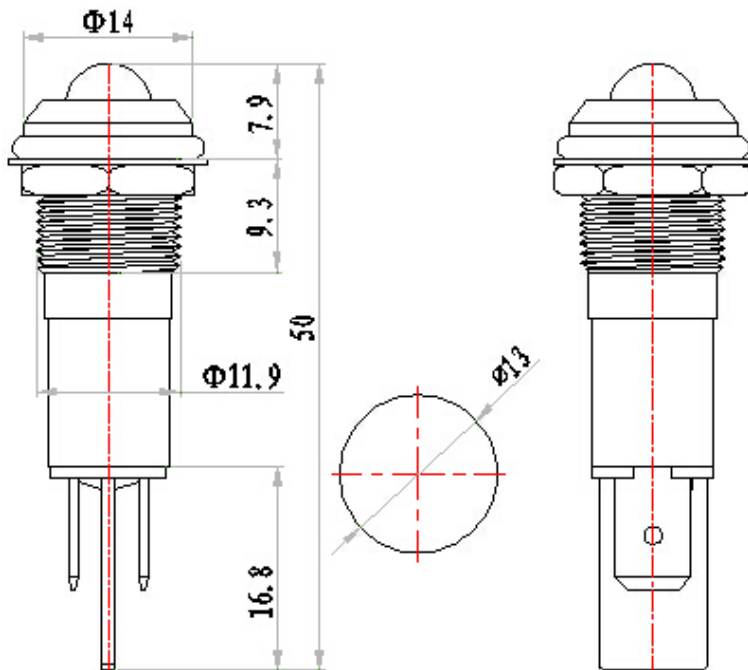



乐清市裕林电子有限公司

Yueqing Yulin Electronic Co., Ltd

Address: 721 huancheng east road tantou liushi yueqing wenzhou Tel: 0577-27878383

website: www.pilotlamp.cn

fax: 0577-27878383-8027

3 配件材料 component material

4 性能参数 performance parameter

| 配件名 Component name | 材料 material |
|--------------------|---|
| 灯罩 lens | PC塑料 PC plastic |
| 金属壳 Metal body | H59 黄铜 or 204 不锈钢 H59 brass or 204 stainless steel |
| 加固垫片 washer | T10 冷轧钢 T10 Cold Rolled Steel |
| 防水圈 rubber ring | SIL 硅胶 SIL silica gel |
| 螺帽 nut | H59 黄铜 H59 nickel plated brass |
| 灯座 housing | PA66 阻燃尼龙 PA66 nylon |
| 光源 Light source | LED LED灯 |
| 电阻 Resistor | 金属膜电阻 Metal film |
| 导线 Cable | |
| 插件 plug-in | C2680 环保铜 C2680 RoHS brass |

| 项目 items | 参数 parameter |
|---|------------------|
| 额定电压 Rated voltage | 3V-780V DC or AC |
| 额定电流 rated current | 20mA |
| 额定功率 rated power | 0.2W |
| 绝缘耐压 Insulation and voltage resistance | 1800V |
| 工作寿命 working life | 100000h |
| 电气寿命 electrical life | 100000次 |
| 耐寒 cold-resistant | -40℃ |
| 耐热 heat-resisting | 80℃ |



乐清市裕林电子有限公司
Yueqing Yulin Electronic Co., Ltd

Address: 721 huancheng east road tantou liushi yueqing wenzhou Tel: 0577-27878383

website: www.pilotlamp.cn

fax: 0577-27878383-8027

4. Detailed Picture led 图片:



5. LED Specification led 说明:

■ Emitter 外型图

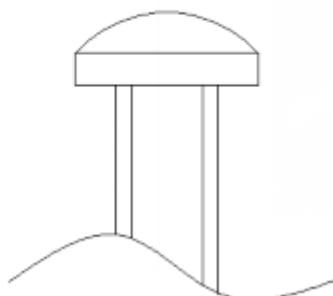
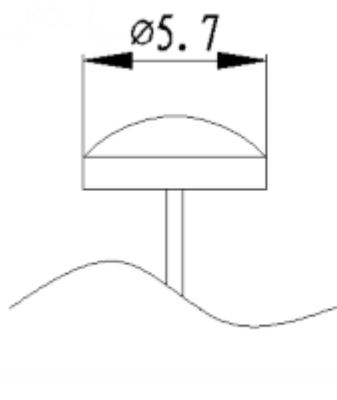

Spatial Distribution

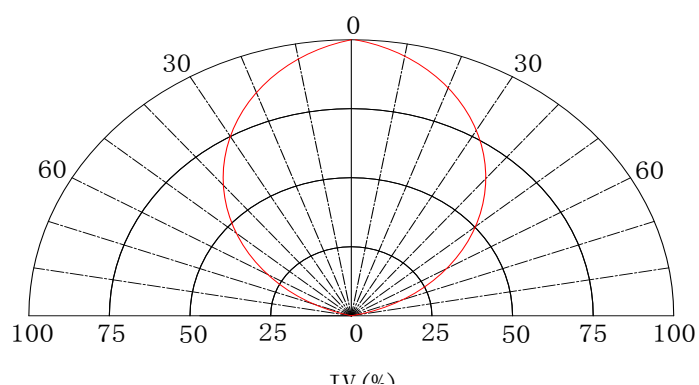



乐清市裕林电子有限公司

Yueqing Yulin Electronic Co., Ltd

Address: 721 huancheng east road tantou liushi yueqing wenzhou Tel: 0577-27878383

website: www.pilotlamp.cn

fax: 0577-27878383-8027

■ Absolute Maximum Rating 极限工作参数

| 参数 Parameter | 符号 Symbol | 单位 Unit | 极限参数 Maximum Rating |
|---------------------------------------|--------------|------------|------------------------|
| 耗散功率 Power Dissipation | P | MW | 60 |
| 连续正向电流 Continuous Forward Current | I_F | MA | 25 |
| 反向电压 Reverse Voltage | V_R | V | 5 |
| 工作温度范围 Operating Temperature Range | T_{op} | °C | -25 to +80 |
| 存放温度范围 Storage Temperature Range | T_{st} | °C | -25 to +90 |
| 最高焊接温度 Soldering Temperature | T_{so} | °C | 260 (for 5 second) |

*Ifp Conditions: Pulse Wide $\leq 10\text{msec} \leq 1/10$ 瞬间脉冲电流

*Tsol Conditions: 3mm from the base of epoxy bulb 最高焊接温度 距胶体 3mm

Typical electrical-optical Characteristics curvers

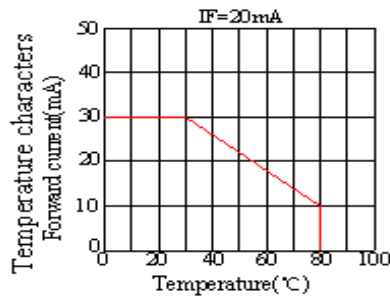
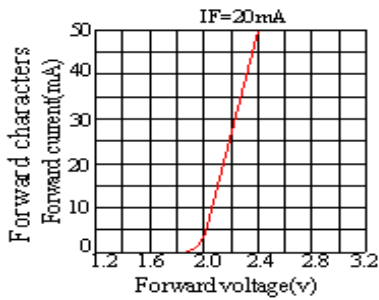

Notes:

The data are an typical presentation of the product, Contact customer service for details of technical information and warranty.

The product is sensitive to static antistatic operation environment is recommended

Products are shipped in either bulk bag package or taping.

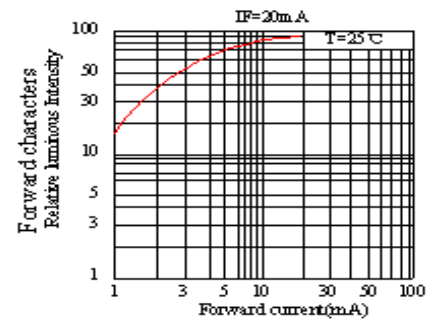
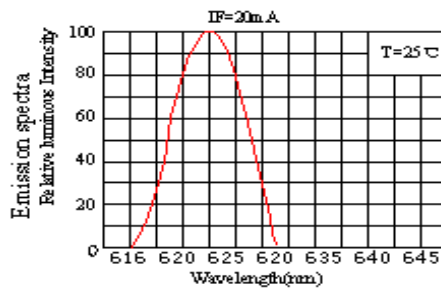
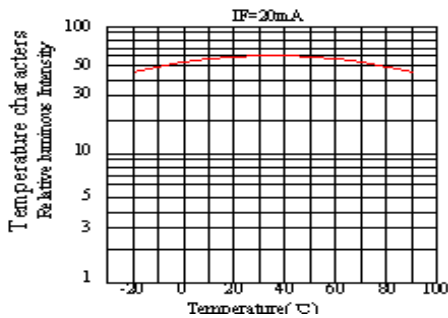



■ Typical Optical/Electrical Characteristics 光电特性参数

| | | | |
|------------------------------------|--------------|-----------------------------|------------------------|
| Color parameters 色参数 | | Optical Brightness 光亮度 | 0.00 cd/m ² |
| Main Wavelength 主波长 | 520.7.0 nm | light intensity 光强度 | 1000 mcd |
| Peak Wavelength 峰值波长 | 632.2 nm | luminous flux 光通量 | 4.8 lm |
| Peak width 峰值带宽 | 21.3 nm | luminous power 光功率 | 0.32 mW |
| colour coordinates xy 色坐标xy | (.1404.7126) | luminous efficacy 发光效率 | 56.81 lm/W |
| colour coordinates u'v' 色坐标u'v' | (.0498.5690) | forward current 正向电流 | 20.00 mA |
| colour purity 色纯度 | 0.758 | alternating voltage 交流电压 | 4.22 V |
| Color temperature 色温 | 8400k | AC power 交流电功率 | 0.084 W |

Notes:

1. Work absolute ratings Ta=25°C humidity=60% 工作常规值 温度=25°C 湿度=60%
2. Tolerance of measurement of forward voltage±0.1V 正向电压误差范围±0.1V
3. Test Machine: SSP6612 series LED test system



Yueqing Yulin Electronic Co., Ltd

Address: 721 huancheng east road tantou liushi yueqing wenzhou Tel: 0577-27878383

website: www.pilotlamp.cn

fax: 0577-27878383-8027

LED LAMP RELIABILITY

● **Test Items And Results**

* Refer to reliability test standard specification for in this line.

| Type | Test Item | REF. Standard | Test Condition | Note | Number of Damaged |
|------------------------|------------------------------|------------------------|---|----------------------|-------------------|
| Environmental Sequence | Temperature Cycle | JIS C 7021 (1997) A-4 | -20°C→25°C→80°C→25°C 30mins,5mins,30mins,5mins | 100 cycles | 0/100 |
| | High Humidity Heat Cycle | JIS C 7021 (1997) A-5 | 30°C→65°C 90%RH 24hrs/1cycle | 10 cycles | 0/100 |
| | High Temperature | JIS C 7021 (1997) B-10 | Ta=80°C | 1000hrs | 0/100 |
| | Humidity Heat Storage | JIS C 7021 (1997) B-11 | Ta=60°C RH=90% | 1000hrs | 0/100 |
| | Low Temperature | JIS C 7021 (1997) B-12 | Ta= -30°C | 1000hrs | 0/100 |
| Operation Sequence | Life Test | JIS C 7035 (1985) | Ta=25°C If=20mA | 1000hrs | 0/100 |
| | High Humidity Heat Life Test | * | 60°C RH=90% If=20mA | 500hrs | 0/100 |
| | Low Temperature Life test | * | Ta= -20°C If=20mA | 1000hrs | 0/100 |
| Destructive Sequence | Resistance to Soldering Heat | JIS C 7021 (1997) A-11 | Tsol=260 ± 5°C,10sec (3mm from the base of the epoxy bulb) | 1 time | 0/20 |
| | Solder ability | JIS C 7021 (1997) A-2 | Tsol=235 ± 5°C,5sec (Using flux) | 1 time (over 95%) | 0/20 |
| | Lead Pull/Bend Test | JIS C 7021 (1997)A-11 | Load 2.5N (0.25kgf) 0°→90°→0° Bending 3 times | No noticeable damage | 0/20 |

● **Criteria for Judging The Damage**



乐清市裕林电子有限公司
Yueqing Yulin Electronic Co., Ltd

| Item | Symbol | Test Condition | Criteria for Judgment | |
|--------------------|----------------|----------------------|-----------------------|--------------------|
| | | | Min. | Max. |
| Forward Voltage | V _F | I _F =20mA | --- | Initial data x 1.1 |
| Reverse Current | I _R | V _R = 5V | --- | Initial data x 2.0 |
| Luminous Intensity | I _V | I _F =20mA | Initial data x 0.7 | --- |

6. Resistor Specification (RMS 1/4W 200kΩ):

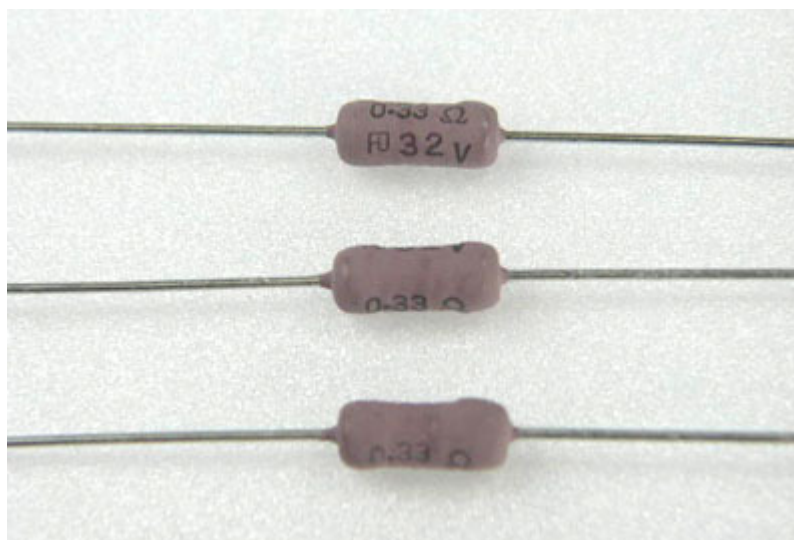

CHARACTERISTICS 性能

| ITEM 项目 | SPEC 规格 | REMARKS 备注 |
|--|---|---|
| Load life under high temperature 高温负荷寿命 | ±1.5% | JIS C 5201-1 (4.25.1) Rated voltage at 70°C for 1,000 hours 额定电压70°C 1,000小时 |
| Load life under high humidity 耐湿负荷寿命 | ±5% | JIS C 5201-1 (4.24) Rated voltage at 40°C, 95% RH for 1,000 hours 额定电压40°C, 95% RH 1,000小时 |
| Temp. coeff of resistance 温度系数 | < 1K= ±500 PPM/°C ≤ 100KΩ= ±300 ppm/°C > 100KΩ= ±200 ppm/°C | JIS C 5201-1 Room temp. + 100°C, 30min 室温 + 100°C, 30分钟 |
| Short time overload 短时间过负荷 | ±1% | JIS C 5201-1 (4.13) 6.25 times the rated power for 5 seconds 6.25倍额定功率 5秒 |
| Temperature cycling 温度循环 | ±1% | JIS C 5201-1 (4.19) 5 cycles for -25°C±3°C(30min); room temp.(30min) ~ +85°C±3°C(30min) room temp. (30min) |
| Resistance to soldering heat 焊锡耐热 | ±1% | JIS C 5201-1 (4.18) 260°C±5°C for 10 seconds(焊锡槽) 350°C±10°C for 3.5 seconds(手焊锡) |
| Insulation resistance 绝缘电阻 | >1,000MΩ | JIS C 5201-1 (4.6.1.1) 500 volt Insulation test 1min 500 V绝缘测试电压1分钟 |



乐清市裕林电子有限公司

Yueqing Yulin Electronic Co., Ltd

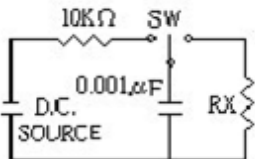
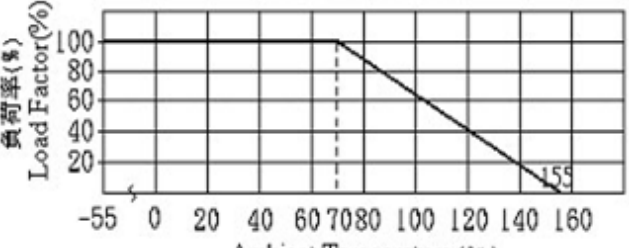
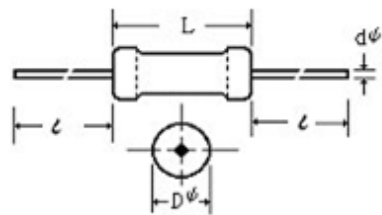
| | | |
|--|-------------|--|
| <p>Pulse withstanding voltage 脉冲</p> | <p>±20%</p> | <p>■ The following discharge cycle is repeated in the circuit of the left fig. 2.5 sec. ON 2.5 sec. OFF 50 cycles. With following DC pulse test voltage ■ Pulse voltage: 1/6W, S1/4W: 3KV. ≥ 1/4W: 100KΩ: (3KV); 100KΩ-620KΩ: (5KV); > 620KΩ: (10KV)</p>  |
| <p>DERATING CURVE 额定功率下降曲线</p>  | |  |
| | | <p>Various type of forming & taping are available</p> |
| | | <p>提供插装的造型与带装</p> |
| | | <p>Coating color: RMU1/4W, RMU1/6W, dark blue, other, pink.</p> |
| | | <p>涂装颜色: RMU1/4W, RMU1/6W 蓝色, 其他粉红色。</p> |

■ CHARACTERISTICS 性能

| Model 型号 | Power Rating 额定功率 (W) | Resistance Range E-24 阻值范围 Ω | Maximum Working Voltage 最高使用 电压 | Dielectric Withstandi ng Voltage 耐电压 | Dimension 尺寸 (mm) | | | |
|-------------------------|--------------------------------|---------------------------------------|---|--|-------------------|---------|------|----------|
| | | | | | L | D φ | t | d φ |
| RMU1/4W 、 RMS1/2W | 1/4, 1/2 | 10Ω ~ <100M | 1600V | 700V | 6±0.3 | 2.4±0.1 | 28±2 | 0.6±0.05 |