



Anti Vandal Switch \varnothing 19mm

Order Code

Series	Actuator Options	Terminal Options	Function Options	Material Options	Illumination Style Options	Led- Color Options	Illumination Voltage Options	Graphic Options
<input type="checkbox"/> <input type="checkbox"/>	<input type="checkbox"/>	<input type="checkbox"/>	<input type="checkbox"/>	<input type="checkbox"/>	<input type="checkbox"/>	<input type="checkbox"/>	<input type="checkbox"/>	<input type="checkbox"/> <input type="checkbox"/> <input type="checkbox"/>
L19T	F-Flat	NONE -Solder lug (2.8X0.5)	M-Momentary 1-1NO1NC Z-Latching 1-1NO1NC	S-Stainless steel A-Anodized aluminum	NONE -Non-illum. D-Dot R-Ring PS-Power backlit symbol PY-Ring illum.& Power backlit symbol	NONE -Non-illum. W-White Y-Yellow B-Blue G-Green R-Red 3A-Red/ Green/ Blue	NONE -Base voltage* 3.3V 6V 12V 24V 36V 110V 220V	NONE -Non-marking LE-Laser etched

Notes:
 * Base voltage on LEDs:
 1.8V @20mA for red and yellow LED colors
 2.8V @20mA for blue, green and white LED colors

Description

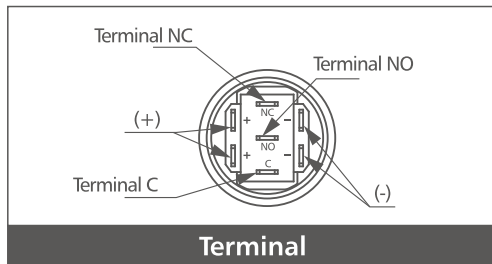

C = Common
 NO = Normally open
 NC = Normally closed

Terminals (-) and (+) used with illum. option only

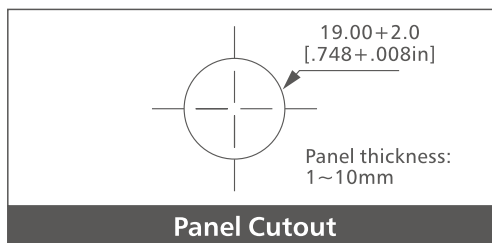

Technical Data

Type	L19T-F
Illuminated options	Non-illuminated / Ring illuminated / Dot illuminated
Terminal	Solder lug (2.8X0.5)
Max. switch rating	Ith: 3A Ui: 250VAC
Contact resistance	≤50mΩ
Insulation resistance	≥1000mΩ
Dielectric strength	2000VAC
Operation temp.	-20°C ~ +55°C
Mechanical life	1,000,000 cycles
Electrical life	100,000 cycles
Contact material	Silver alloy
Torque	5~14Nm
Operation pressure	Approx. 5N
Protection	IP65/ IK09
Material	
Actuator	Stainless steel / Anodized aluminum
Body	Stainless steel / Anodized aluminum
Base	PBT
	LED
Color	3.3V / 6V / 12V / 24V / 36V / 110V / 220V Approx, 40,000 hours

Dimensions

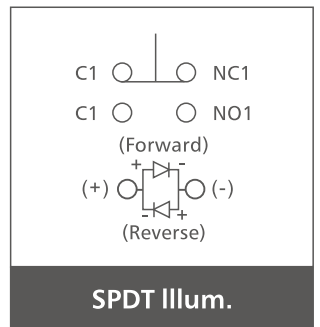
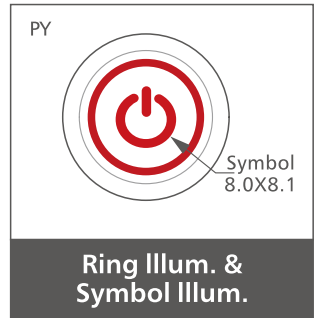
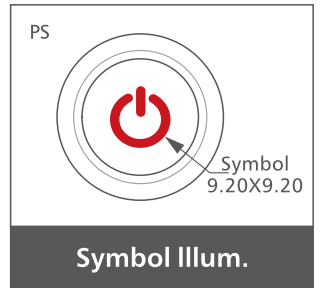
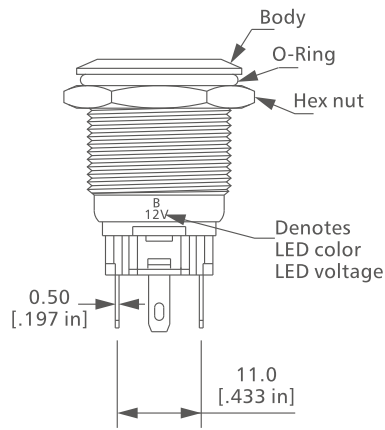
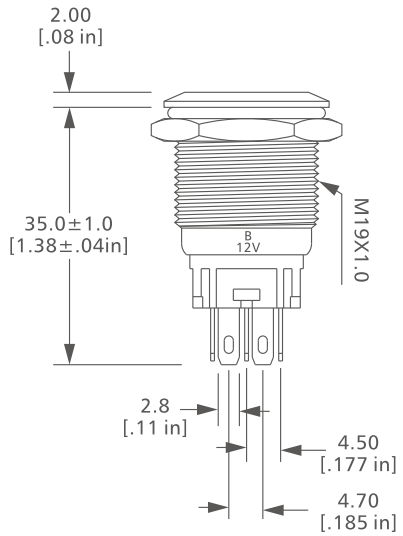
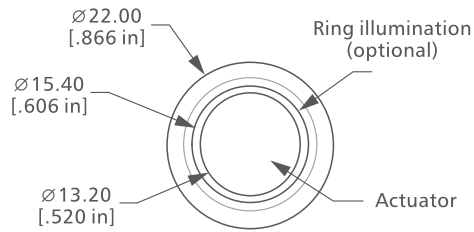

Illum. Options

