



TOYO LED ELECTRONICS LIMITED

Unit 10-11, 19/F, Metro Loft, 38 KwaiHei Street, Kwai Chung, N.T., Hong Kong

Tel : (852) 2540 7288

http://www.toyo-led.com

Fax : (852) 2517 1797

E-mail : sales@toyo-led.com



P/N: TY-5050CW1

5.0 * 5.0mm TOP SMD Series

SPECIFICATION FOR CUSTOMER APPROVAL

P/N:TY-5050CW1

DATE : July 4, 2017

PREPARED BY : Chen Li fen

CONFIRMED BY :



PLEASE CONFIRM & SIGN BACK THIS SHEET TO US

CUSTOMER:

(COMPANY CHOP)

APPROVAL BY:

(SIGNATURE)



TOYO LED ELECTRONICS LIMITED

Unit 10-11, 19/F, Metro Loft, 38 KwaiHei Street, Kwai Chung, N.T., Hong Kong

Tel : (852) 2540 7288

http://www.toyo-led.com

Fax : (852) 2517 1797

E-mail : sales@toyo-led.com



P/N: TY-5050CW1

5.0 * 5.0mm TOP SMD Series

◆ Features:

- 5.0mm×5.0mm SMT LED, 1.60mm thickness
- PLCC-6package
- White package
- Suitable for all SMT assembly and solder process
- Available on 8mm tape and on 178mm reel

◆ Description

The white source color devices are made with InGaN on sapphire Light Emitting Diode.

◆ Application

- Optical indicator
- Indicator and backlighting in telephone and fax
- Flat backlight for LCD, switch and symbol
- Light pipe application
- General use

◆ Package Outline Dimensions

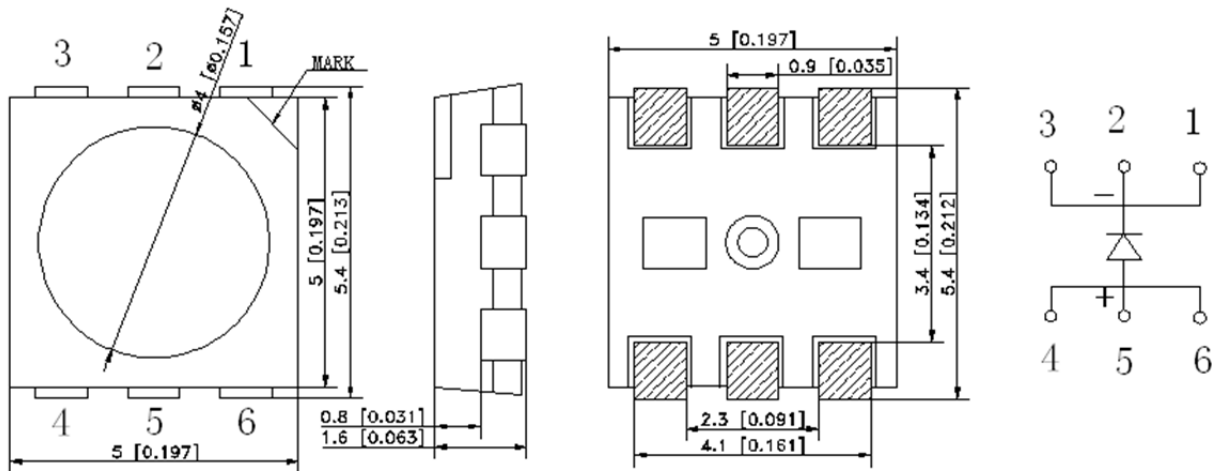

NOTES:

1. All dimensions are in millimeter;
2. Tolerance is ± 0.2 mm unless other specified;
3. Specifications are subject to change without notice.



TOYO LED ELECTRONICS LIMITED

Unit 10-11, 19/F, Metro Loft, 38 KwaiHei Street, Kwai Chung, N.T., Hong Kong
 Tel : (852) 2540 7288 Fax : (852) 2517 1797
 http://www.toyo-led.com E-mail : sales@toyo-led.com



P/N: TY-5050CW1

5.0 * 5.0mm TOP SMD Series

Part No.	Emitted Color	Len's Color	Chip Material
TY-5050CW1	Cool white	Yellow	InGaN

✧ Absolute Maximum Ratings(Ta=25°C)

Item	Symbol	Maximum	Unit
Power Dissipation	P _D	85	mW
Forward Current	I _F	25	mA
Peak Forward Current(1/10 Duty Cycle 0.1ms Pulse Width)	I _{FP}	80	mA
Reverse Voltage	V _R	5	V
Operating Temperature Range	T _{opr} / T _{stg}	-40 to+85	°C
Storage Temperature Range	T _{opr} / T _{stg}	-40 to+85	°C

✧ Electrical/Optical Characteristics(Ta=25°C)

Item	Symbol	Condition	Min.	Typ.	Max	Unit
Forward Voltage	V _F	I _F =20mA	2.7	3.4	--	V
Luminous Intensity	I _V	I _F =20mA	--	1200	--	mcd
Coordinates	X	I _F =20mA	--	0.265	--	--
	Y	I _F =20mA	--	0.260	--	--
Color Temperature	C _T	I _F =20mA	--	12000	--	K
Viewing Angle	2θ _{1/2}	I _F =20mA	--	120	--	Deg
Capacitance	C	V _F =0V, f=1MHZ	--	110	--	pF
Reverse Current	I _R	V _R =5V	--	5	10	uA

NOTES:

1. Tolerance is ±0.25mm unless other specified;
2. Luminous intensity testing tolerance is ±10%;
3. Dominant Emission Wavelength testing tolerance is ±1nm;
4. Specifications are subject to change without notice.



TOYO LED ELECTRONICS LIMITED

Unit 10-11, 19/F, Metro Loft, 38 KwaiHei Street, Kwai Chung, N.T., Hong Kong
 Tel : (852) 2540 7288 Fax : (852) 2517 1797
 http://www.toyo-led.com E-mail : sales@toyo-led.com



P/N: TY-5050CW1

5.0 * 5.0mm TOP SMD Series

Typical Electro-Optical Characteristics Curves

FIG. 5 Relative Intensity Vs. Wavelength

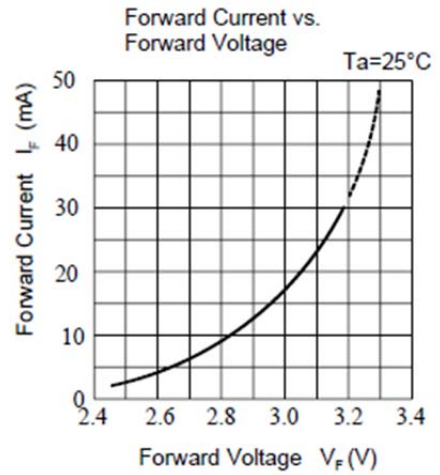
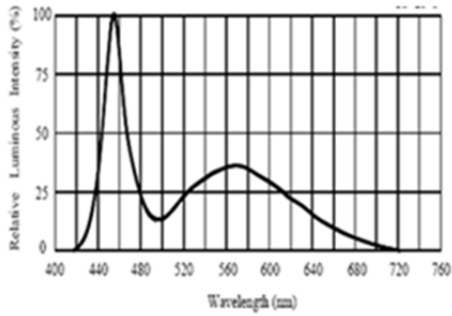

Forward Current VS Ambient Temperature

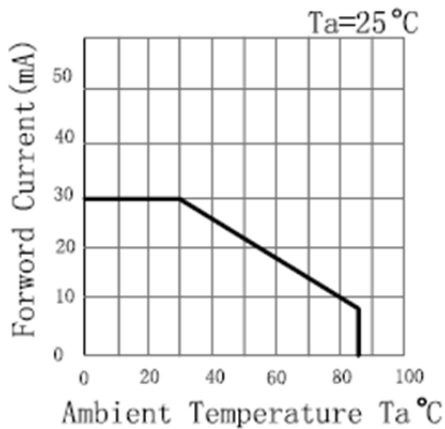

Forward Current Vs. Relative Luminosity

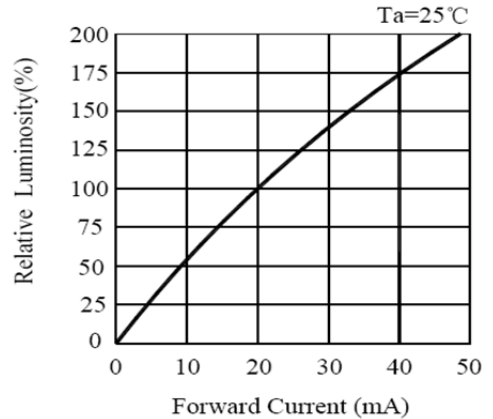

Relative Luminosity Vs. Ambient Temperature

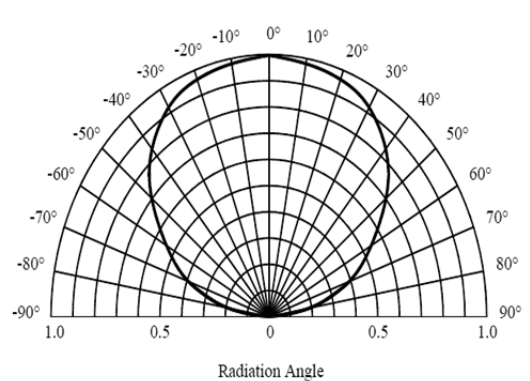
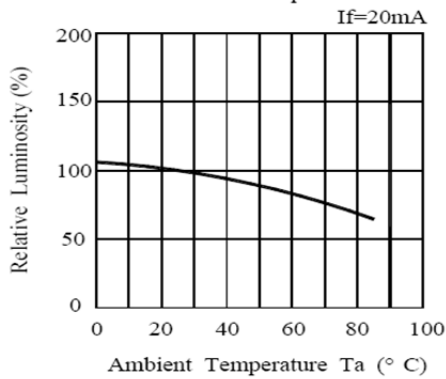



TOYO LED ELECTRONICS LIMITED

Unit 10-11, 19/F, Metro Loft, 38 KwaiHei Street, Kwai Chung, N.T., Hong Kong

Tel : (852) 2540 7288
 http://www.toyo-led.com

Fax : (852) 2517 1797
 E-mail : sales@toyo-led.com



P/N: TY-5050CW1

5.0 * 5.0mm TOP SMD Series

◇ Reliability Test Items And Conditions

NO.	Item	Test Condition	Test Hr/cycle/time	Sample Qty	Ac/Re
1	Reflow	TEMP:260±5°C;	3-7 sec	22pcs	0/1
2	High Temperature /Humidity Storage	TEMP: 85°C/ R.H.:85%	1000hrs	22pcs	0/1
3	Low Temperature Storage	TEMP: -40°C	1000hrs	22pcs	0/1
4	DC Operating Life	If=20mA	1000hrs	22pcs	0/1

◇ Recommended SMT Reflow Soldering Instructions

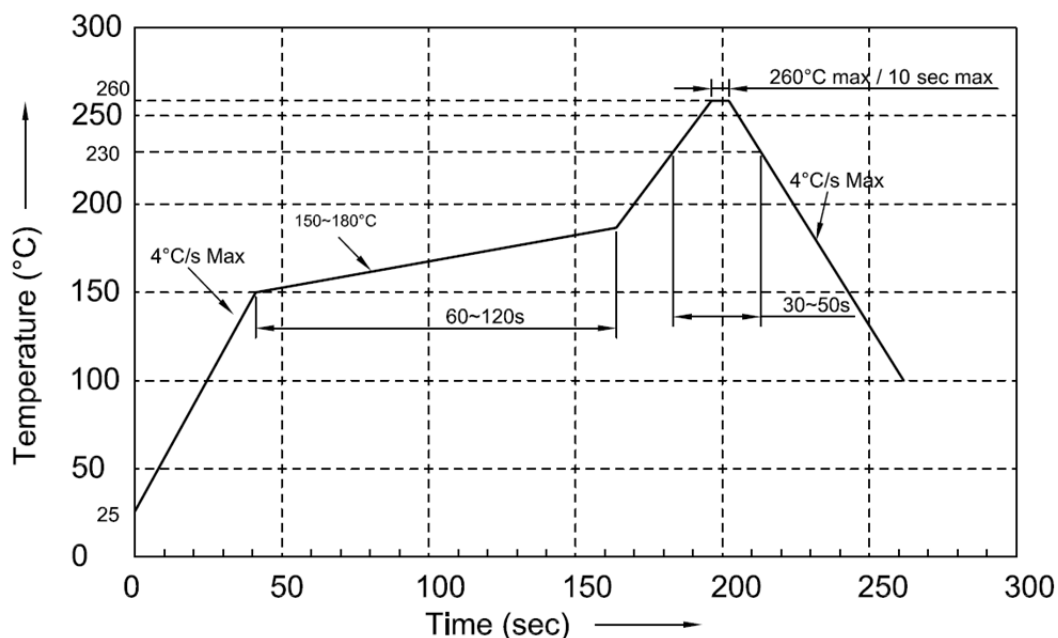

Notes:

1. We recommend the reflow temperature 245±5°C. The maximum soldering temperature should be limited to 260°C for 10s (max).
2. Don't cause stress to the epoxy resin while it is exposed to high temperature.
3. Number of reflow process shall be 2 times or less.



TOYO LED ELECTRONICS LIMITED

Unit 10-11, 19/F, Metro Loft, 38 KwaiHei Street, Kwai Chung, N.T., Hong Kong
Tel : (852) 2540 7288 Fax : (852) 2517 1797
http://www.toyo-led.com E-mail : sales@toyo-led.com



P/N: TY-5050CW1

5.0 * 5.0mm TOP SMD Series

◇ Handling Precautions

Epoxy resin is hard & brittle and silicone is softer & flexible. Although its characteristic significantly thermal stress, it is more susceptible to damage by external mechanical force.

As a result, special handling precautions need to be observed during assembly using silicone encapsulated LED products. Failure to comply might lead to damage and premature failure of the LED.

1. Handle the component along the side surface by using forceps or appropriate tools (fig.1); do not directly touch or Handle the silicone lens surface, it may damage the internal circuitry(fig.2&3).

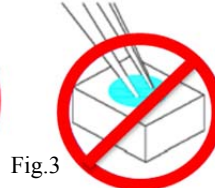
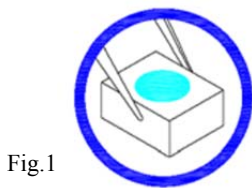

2. The outer diameter of the SMD pickup nozzle should not exceed the size of the LED to prevent air leaks. The inner diameter of the nozzle should be as large as possible. A pliable material is suggested for the nozzle tip to avoid scratching or damaging the LED surface during pickup.

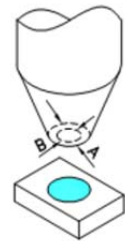

The dimensions of the component must be accurately programmed in the pick-and-place machine to insure precise pickup and avoid damage during production.

3. Prevent stack together assembled PCBs containing LEDs. Impact may scratch the silicone lens or damage the internal circuitry(fig.4).
4. Non-suitable to operate in acidic environment, PH<7. LEDs. (Fig.5)

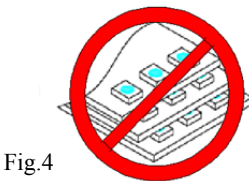

5. LED operating environment and sulfur element composition cannot be over 100PPM in the LED mating usage material.

◇ ESD (Electrostatic Discharge)

Static Electricity or power surge will damage the LED. Use of a conductive wrist band or anti-electrostatic glove is recommended when handing these LED. All devices, equipment and machinery must be properly grounded.

◇ Storage

In order to prevent the absorption of moisture, it is recommended to solder TOYO LEDs as soon as possible after unpacking the sealed envelope.

If the envelope is still packed, to store it in the environment as following:

- ① Temperature:5°C-30°C(41°F-86°F) Humidity: RH 60% Max.
- ② After this bag is opened, devices that will be applied to infrared reflow, vapor-phase reflow, or equivalent soldering process must be:
 - A、 Completed within 168 hours.
 - B、 Stored at less than 30% RH.
- ③ Devices required baking before mounting, if:(2)a or (2)b is not met.
- ④ If baking is required, devices must be baked under below condition:48 hour at 60°C±3°C.



TOYO LED ELECTRONICS LIMITED

Unit 10-11, 19/F, Metro Loft, 38 KwaiHei Street, Kwai Chung, N.T., Hong Kong
Tel : (852) 2540 7288 Fax : (852) 2517 1797
http://www.toyo-led.com E-mail : sales@toyo-led.com



P/N: TY-5050CW1

5.0 * 5.0mm TOP SMD Series

◇ Other

1. Above specification may be changed without notice. TOYO will reserve authority on material change for above specification.
2. When using this product, please observe the absolute maximum ratings and the instructions for using outlined in these specification sheets. TOYO assumes no responsibility for any damage resulting from use of the product which does not comply with the absolute maximum ratings and the instructions included in these specification sheets.
3. These specification sheets include materials protected under copyright of TOYO LED ELECTRONICS LIMITED. Please don't reproduce cause by anyone to reproduce them without TOYO's consent.

◇ Recommended Soldering Pad Dimensions

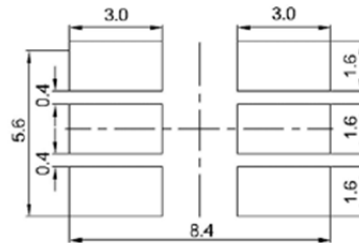

◇ Tape Specification: 2,000pcs per reel

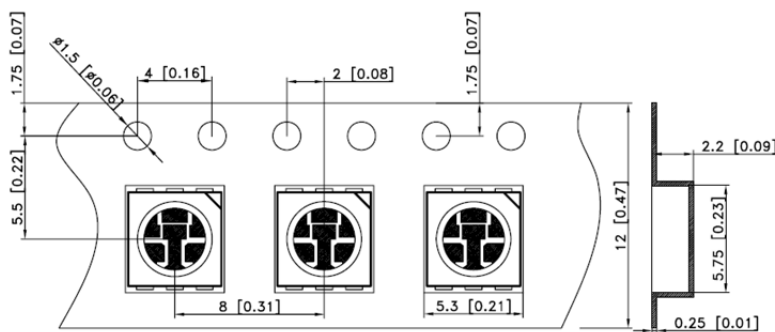
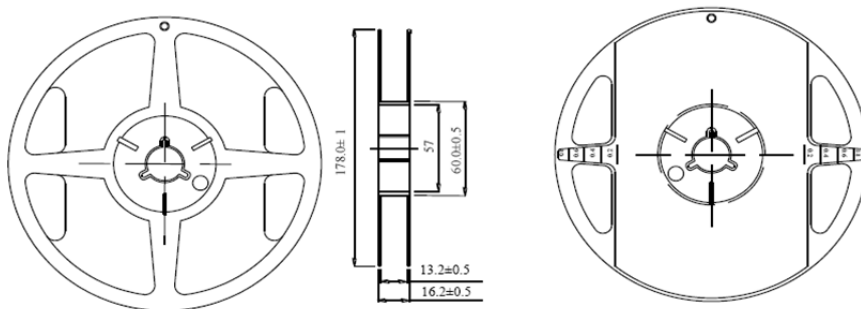

◇ Package Label

SMD LED	
PART NO: _____	QA Pass
LOT NO : _____	
Q' TY : _____	
VF : _____ IV : _____	
WL : _____ BIN: _____	Pb
DATA : _____	
TOYO LED ELECTRONICS LIMITED	
Website: http://www.toyo-led.com E-mail: sales@toyo-led.com	



TOYO LED ELECTRONICS LIMITED

Unit 10-11, 19/F, Metro Loft, 38 KwaiHei Street, Kwai Chung, N.T., Hong Kong
Tel : (852) 2540 7288 Fax : (852) 2517 1797
http://www.toyo-led.com E-mail : sales@toyo-led.com



P/N: TY-5050CW1

5.0 * 5.0mm TOP SMD Series

Package & Shipping Instructions

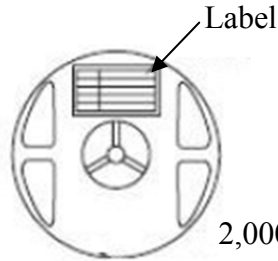

2,000PCS/Reel



Desiccant

Label

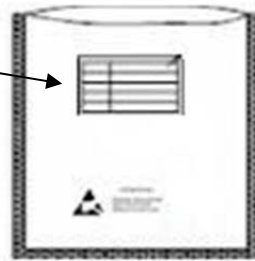

Aluminum moisture-proof bag
Size: 240*216*0.112(mm)

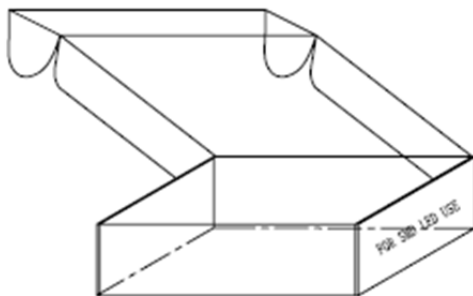

5Reels/Inner Box (10KPCS)
Size: 250*220*68(mm)

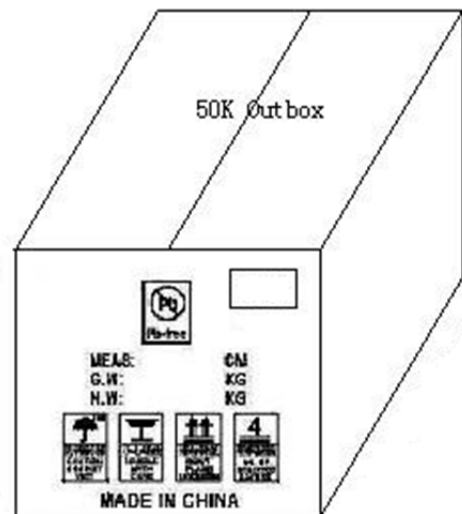

5 Inner boxes/Outer Box (50KPCS)
Size: 350*260*230(mm)



TOYO LED ELECTRONICS LIMITED

Unit 10-11, 19/F, Metro Loft, 38 KwaiHei Street, Kwai Chung, N.T., Hong Kong
Tel : (852) 2540 7288 Fax : (852) 2517 1797
http://www.toyo-led.com E-mail : sales@toyo-led.com



P/N: TY-5050CW1

5.0 * 5.0mm TOP SMD Series

REVISION HISTORY

DATE	REVISION CONTENTS	VERSION
2016-11-16	New	A