



TOYO LED ELECTRONICS LIMITED

Room 1610, Hong Kong Plaza, 188 Connaught Road West, Hong Kong.

Tel : (852) 2540 7288
http://www.toyo-led.com

Fax : (852) 2517 1797
E-mail : sales@toyo-led.com



P/N: TY-5050UY3-1000

5.0 * 5.0mm TOP SMD Series

SPECIFICATION FOR CUSTOMER APPROVAL

P/N:TY-5050UY3-1000

DATE : December 30, 2015

PREPARED BY : Chen Li fen

CONFIRMED BY : Yan Guo liang

PLEASE CONFIRM & SIGN BACK THIS SHEET TO US

CUSTOMER: _____

APPROVAL BY: _____

(COMPANY CHOP)

(SIGNATURE)



TOYO LED ELECTRONICS LIMITED

Room 1610, Hong Kong Plaza, 188 Connaught Road West, Hong Kong.

Tel : (852) 2540 7288

http://www.toyo-led.com

Fax : (852) 2517 1797

E-mail : sales@toyo-led.com



P/N: TY-5050UY3-1000

5.0 * 5.0mm TOP SMD Series

◆ Features:

- 5.0mm×5.0mm SMT LED , 1.60mm thickness
- PLCC-6package
- White package
- Suitable for all SMT assembly and solder process
- Available on tape and reel

◆ Description

The Yellow source color devices are made with AlGaInP on sapphire Light Emitting Diode.

◆ Application

- Optical indicator
- Indicator and backlighting in telephone and fax
- Flat backlight for LCD,switch and symbol
- Light pipe application
- General use

◆ Package Dimensions

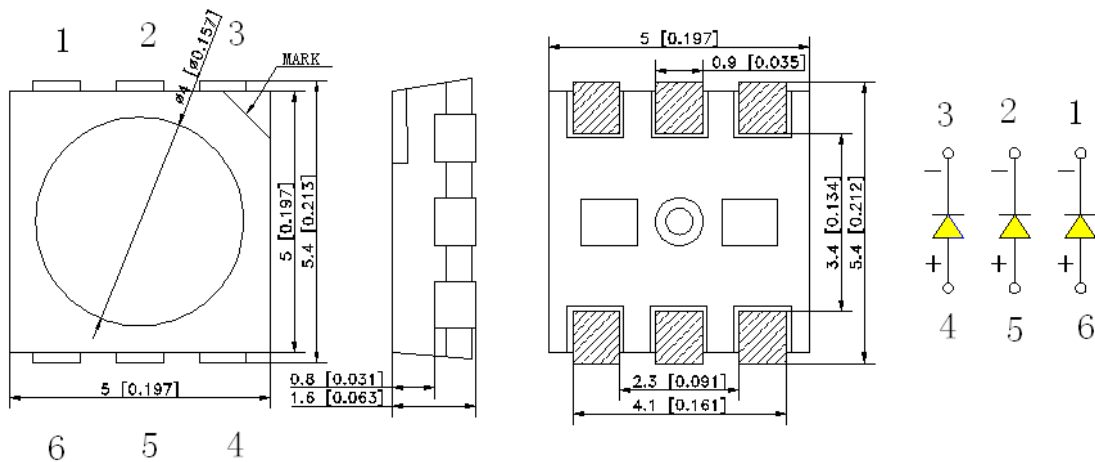

NOTES :

1. All dimensions are in millimeter;
2. Tolerance is±0.2mm unless other specified;
3. Specifications are subject to change without notice.



TOYO LED ELECTRONICS LIMITED

Room 1610, Hong Kong Plaza, 188 Connaught Road West, Hong Kong.

Tel : (852) 2540 7288
http://www.toyo-led.com

Fax : (852) 2517 1797
E-mail : sales@toyo-led.com



P/N: TY-5050UY3-1000

5.0 * 5.0mm TOP SMD Series

Part No.	Emitted Color	Len's Color	Chip Material
TY-5050UY3-1000	Yellow	Water clear	AlGaInP

✧ Absolute Maximum Ratings(Ta=25)

Item	Symbol	Maximum	Unit
Power Dissipation	PD	75	mW
Continuous Forward Current	I _{Fmax}	30	mA
Peak Forward Current(1/10 Duty Cycle 0.1ms Pulse Width)	I _{FP}	90	mA
Reverse Voltage	V _R	5	V
Operating Temperature Range	T _{opr}	-40 to+85	
Storage Temperature Range	T _{stg}	-40 to+85	

✧ Electrical/Optical Characteristics(Ta=25)

Item	Symbol	Condition	Min.	Typ.	Max	Unit
Forward Voltage	V _F	I _F =60mA	1.8	2.1	2.6	V
Luminous Intensity	I _v	I _F =60mA	500	1000	---	mcd
Luminous Flux	ϕ	I _F =60mA	---	---	---	lm
Wavelength	λ	I _F =60mA	585	590	595	nm
Viewing Angle	2θ _{1/2}	I _F =60mA	--	120	--	Deg
Capacitance	C	V _F =0V, f=1MHZ	--	110	--	pF
Reverse Current	I _R	V _R =5V	--	5	10	uA



TOYO LED ELECTRONICS LIMITED

Room 1610, Hong Kong Plaza, 188 Connaught Road West, Hong Kong.

Tel : (852) 2540 7288
http://www.toyo-led.com

Fax : (852) 2517 1797
E-mail : sales@toyo-led.com



P/N: TY-5050UY3-1000

5.0 * 5.0mm TOP SMD Series

◇ Typical Electro-Optical Characteristics Curves

FIG. 1 Forward Current Vs. Forward Voltage

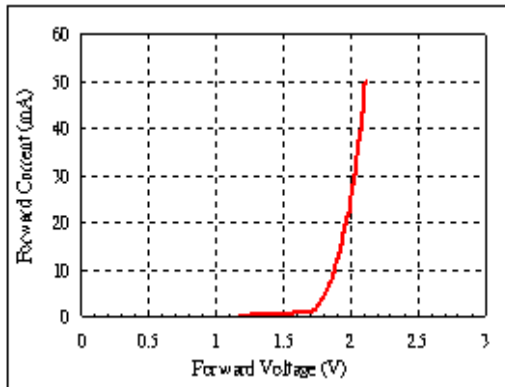

FIG. 2 Relative Intensity Vs. Forward Current

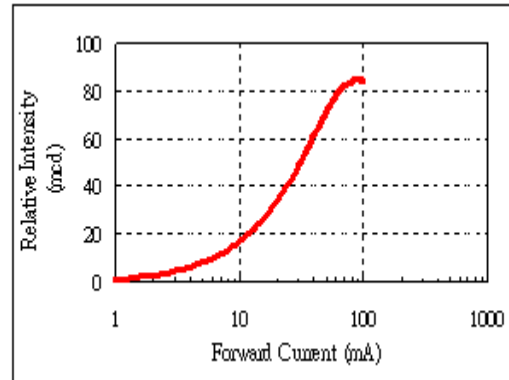

FIG. 3 Forward Voltage Vs. Temperature

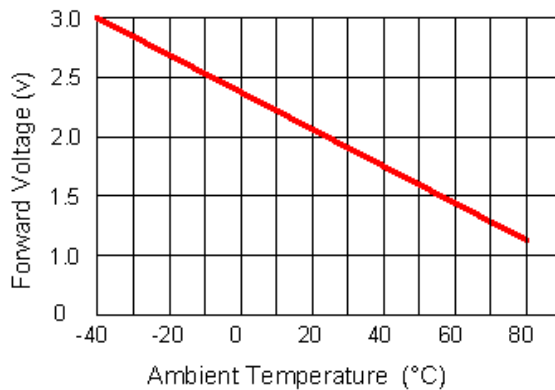

FIG. 4 Relative Intensity Vs. Temperature

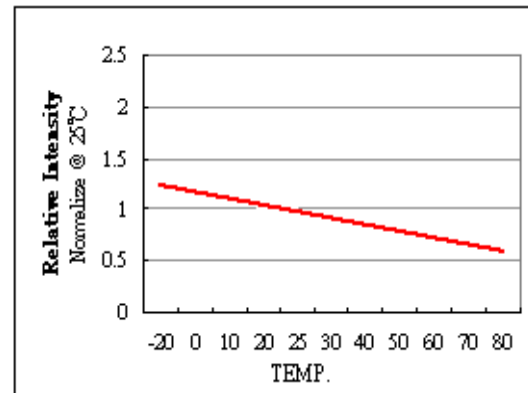
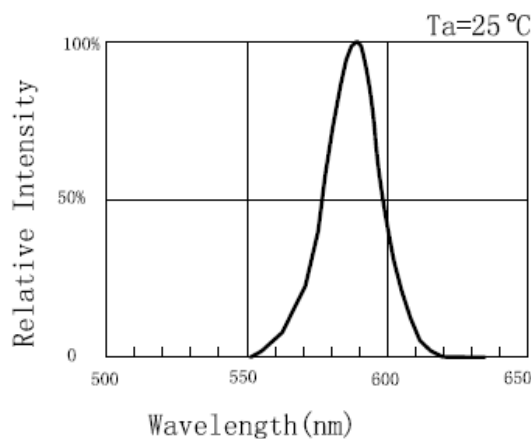

FIG. 5 Relative Intensity Vs. Wavelength





TOYO LED ELECTRONICS LIMITED

Room 1610, Hong Kong Plaza, 188 Connaught Road West, Hong Kong.

Tel : (852) 2540 7288
http://www.toyo-led.com

Fax : (852) 2517 1797
E-mail : sales@toyo-led.com



P/N: TY-5050UY3-1000

5.0 * 5.0mm TOP SMD Series

◇ Reliability Test Items And Conditions

NO.	Item	Test Condition	Test Hr/cycle/time	Sample Q'ty	Ac/Re
1	Reflow	TEMP:260±5 ; Min.5Sec	6 min	22pcs	0/1
2	High Temperature Storage	TEMP: 85	1000hrs	22pcs	0/1
3	Low Temperature Storage	TEMP:-40	1000hrs	22pcs	0/1
4	DC Operating Life	IF=20MA	1000hrs	22pcs	0/1
5	High Humidity	85%R.H.	1000hrs	22pcs	0/1

◇ SMT Reflow Soldering Instructions

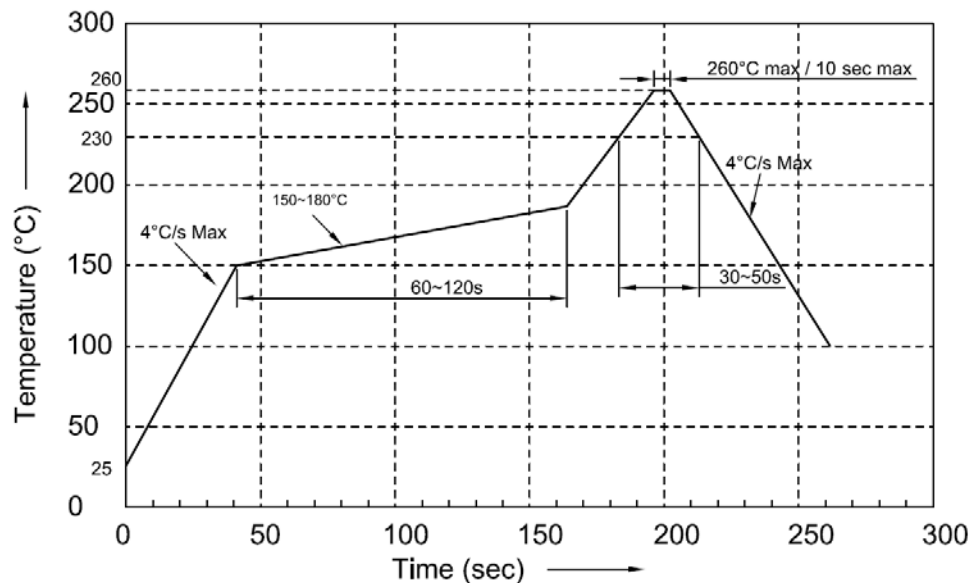

Notes:

1. We recommend the reflow temperature 245±5 .The maximum soldering temperature should be limited to 260 for 10s (max).
2. Don't cause stress to the epoxy resin while it is exposed to high temperature.
Number of reflow process shall be 2 times or less.



TOYO LED ELECTRONICS LIMITED

Room 1610, Hong Kong Plaza, 188 Connaught Road West, Hong Kong.
Tel : (852) 2540 7288 Fax : (852) 2517 1797
http://www.toyo-led.com E-mail : sales@toyo-led.com



P/N: TY-5050UY3-1000

5.0 * 5.0mm TOP SMD Series

Package & Shipping Instructions

